

7W HALED III WGU10 345lm
HALED III WGU10 KC50T7

RoHS CE



Features

- Special HALED design with Anti-Glare Lens and Reflector
- High CRI with Ra95
- Switching power supply
- CE and RoHS compliant
- Perfect dimming function
- 85% energy saving

Applications

- Home, villa and other residential buildings
- Shopping mall, Hotels, restaurants, bars, cafes

Product Overview

Part No.	HALED III WGU10 KC50T7-25501
Wattage (W)	7
Incandescent Equivalent (W)	50
Dimmable	DTW
Socket	GU10
Lumens (lm) by 90°	345
Luminous intensity(cd)	900
Energy efficiency class	A
PF	0.85
CCT (K)	2700-2100
CRI (Ra)	95
Voltage (V)	AC200-240V
Current (mA)	35
Frequency(Hz)	50/60
Beam Angle (deg)	24/36/60
Lifespan(hrs)	25000
Working Temperature (°C)	-20 - 40
Storage Temperature (°C)	-20 - 60
EAN Code	40 6057425501

7W HALED III WGU10 HALED95 DGU10 KP01T9

Physical data

Weight (g)	70
Lamp Length (mm) - C/L	56
Max. Lamp Diameter (mm) - D	50
Lamp dimension equal to filament lamp equivalent	Yes
Designed for optimum use in non standard conditions	No
Fluorescent lamp replacement	No
Single packaging type	Box
Single package dimensions (L x W x H) (cm)	55 x 55 x 68 / 1PCS
Inner package dimensions (L x W x H) (cm)	290 x 118 x 88 / 10PCS
Outer package dimensions (L x W x H) (cm)	615 x 305 x 196 / 100PCS

* Compatible dimmer: Busch Jaeger 6517U-101 / Merten MEG5133 / GIRA 030000/IT01

* Do not use in close luminaire.

Technical Drawings

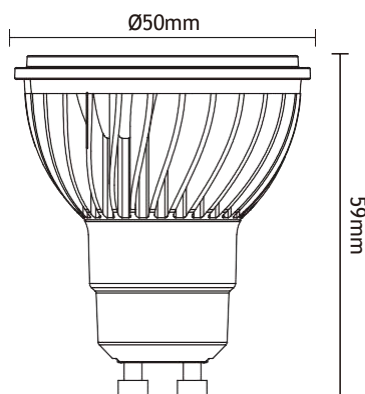

Energy Label

